

Guardian Class 1 Biological Safety cabinet

INSTALLATION, OPERATION AND MAINTENANCE MANUAL

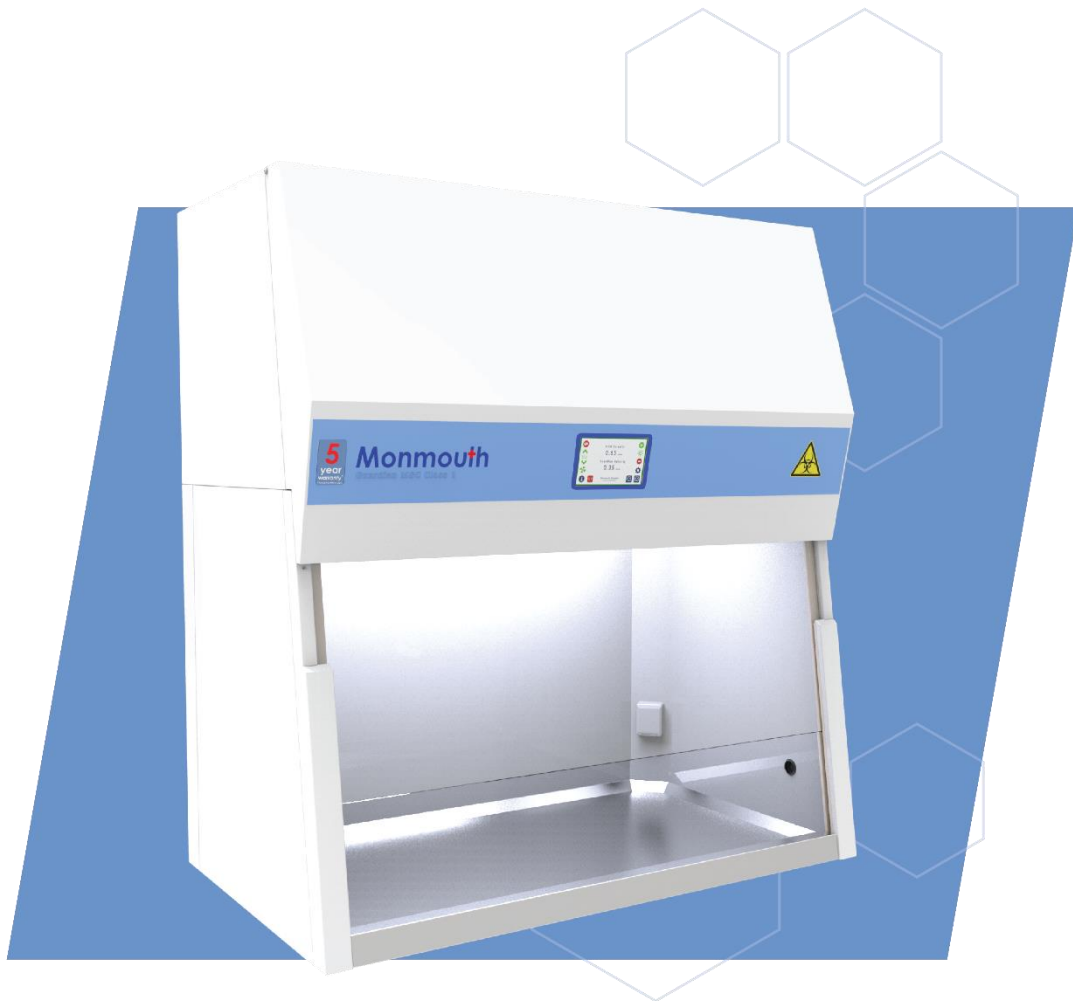

Table of Contents

SECTION 1	4
GENERAL NOTES	4
WARRANTY.....	7
DESCRIPTION	8
CONFIGURATION	8
TECHNICAL DATA.....	9
NORMAL ENVIRONMENTAL CONDITIONS	10
SECTION 2	10
PACKAGED ITEMS	10
INSTALLATION AND ASSEMBLY	10
INSTALLATION (GENERAL).....	11
INSTALLING ABV OPTION	12
CONNECTIONS	13
AUXILIARY SWITCHED CONNECTION	14
TESTING / COMMISSIONING	14
SECTION 3	15
GENERAL OPERATION.....	15
SWITCH THE CABINET ON.....	15
CONTROL PANEL	16
SLIDING SASH OPERATION.....	17
SYSTEM STATUS DISPLAY AREA.....	19
STANDBY	19
SWITCH OFF.....	20
LIGHTING	20
AUXILIARY POWER SOCKETS	21
SECTION 4	22
CLEANING AND DECONTAMINATION	22
GENERAL CLEANING	22
GLASS FRONT CLEANING AND DECONTAMINATION.....	22
UV DISINFECTION	23
DECONTAMINATION WITH FORMALDEHYDE – INTRODUCTION	25
PREPARATION PRIOR TO DECONTAMINATION.....	25
SECTION 5	30
SUPERVISOR SETTINGS.....	30
SECTION 6	35
MAINTENANCE	35

FUSES.....	35
<i>Replacing Main Fuse</i>	35
<i>Replacing Auxiliary Fuses</i>	36
<i>UV lamp – changing</i>	37
FILTER CHANGING.....	38
<i>Replace prefilters</i>	39
<i>Replace main HEPA filters</i>	40
<i>DOP test facilities</i>	42
<i>Replace Carbon exhaust filters</i>	43
SECTION 7	46
SERVICING	46

This manual is intended to provide information about the product. Monmouth Scientific Limited assumes no liability whatsoever for the accuracy of any information contained herein, as products can be subject to improvement and/or changes at any time.

The contents may not be distributed, shared or commercially exploited in any form or by any means, redistributed or reproduced in entirety or in part in any form, for individual or third-party use, photocopied or stored on any form of electronic retrieval system or linked to any other website without the prior express written permission of Monmouth Scientific Limited.

For permission requests, please write to:-

*Monmouth Scientific Limited
Units 5 & 5 Kilnside, East Quay
Bridgwater
Somerset
TA6 4DB.*

	WARNING
	This cabinet must be used in compliance with these instructions and any repairs or maintenance carried out by qualified personnel. See explanation of hazard symbols at the end of this document.

For parts or service information please contact Monmouth Scientific:



info@monmouthscientific.co.uk



+44 (0) 1278 458090









<https://monmouthscientific.co.uk>

SECTION 1

General notes

Symbols used in this manual

	DANGER
	Indicate[s] a hazardous situation which, if not avoided, <i>will</i> result in death or serious injury.
	WARNING
	Indicate[s] a hazardous situation which, if not avoided, <i>could</i> result in death or serious injury.
	CAUTION
	Indicate[s] a hazardous situation which, if not avoided, could result in minor or moderate injury.
	BIOHAZARD
	Hazardous biological materials present.
	ELECTRICAL HAZARD
	Indicates an electrical hazard which, if not avoided, <i>could</i> result in death or serious injury.
	NOTE
	Best practice, housekeeping, security permissions and general notices which don't necessarily indicate a hazard.

General Safety instructions for service work and repairs

Servicing or repairs to this product must be carried out only by personnel with the appropriate qualifications and training. They must have been specifically trained and authorised to work on Monmouth Scientific cabinets.

Allowing unauthorised personnel to carry out service or repairs will invalidate the product warranty.

Prior to carrying out any service on the product or changing any components this service document must be read carefully and fully understood.

Note:

- Local regulations must be adhered to when any service work is carried out.
- Any electrical work is to be carried out by trained electricians.
- Any work on gas lines / supplies is to be carried out by appropriately certified personnel.
- For any service issues not covered adequately in this manual, please immediately contact Monmouth Scientific.
- The contents of this manual may change or be updated without notice.

	BIOHAZARD
	<p>This cabinet could be used for manipulations of bio hazardous and toxic materials therefore internal components and filters could be contaminated. Service personnel must therefore observe strict safety precautions when handling potentially contaminated material.</p>

Be aware that prior to service or maintenance on any potentially contaminated zone, the cabinet is decontaminated, and any hazardous residue is removed.

It is recommended that:

- Prior to any maintenance work, the users should be asked about the potential hazardous materials used and make sure that the cabinet is cleaned and decontaminated.
- Proof or certification of decontamination from the operator/customer is presented to the service engineer.

	ELECTRICAL HAZARD

Motor driven components (e.g. fans / window motors) may cause injury if switched on accidentally.

Prior to any repair work it is recommended to:

- Isolate the cabinet from the electrical supply
- Ensure the cabinet cannot be reconnected accidentally
- Ensure any components such as capacitors etc. are fully de-energized.

	WARNING
	Hazardous Gases

- If the cabinet is connected to an external gas supply then this must be shut off before service or repairs.
- Ensure the work area is adequately ventilated.
- Read any data sheets for gas supply / fittings.
- Report any faulty with parts or supply pipes etc. to cabinet user / facility manager.

	Recycling
	All components (with the exception of filters) can be recycled.

The cabinet must be fully decontaminated prior to disposal and a certificate of decontamination must be produced by the operator/customer before removal for disposal or recycling.

	NOTE – Before start-up following repairs or service
	If any safety devices (shielding / earth connections etc.) were removed or disabled prior to or during repairs then the cabinet must not be started up until these devices are re-installed and checked for correct operation.

Standards and safety regulations.

The cabinet (and/or contained parts within), has been tested complies with to, the following standards and directives:

- BS EN 12469:2000
- EN ISO 12100-2:2010
- BS EN ISO 14121:2007
- BS EN 60204-1:2006+A1:2009
- DS/EN 61010-1: 2010
- EN 61326-1:2013
- Machinery Directive 2006/42/EC, as amended

Warranty

Monmouth Scientific Ltd guarantee the operational safety and functions of the cabinet provided that:

- The cabinet is not modified or changed without authorization.
- Only original spare parts or accessories as supplied by Monmouth Scientific are used. Use of non-original parts will invalidate the warranty.
- Maintenance and service checks are carried out at specified intervals.
- The standard warranty period is 5 year from date of delivery.

Full terms and conditions available from:

www.monmouthscientific.co.uk/5-year-warranty/

Description

The Guardian Class 1 Biological Safety Cabinet is a Class 1 biological safety cabinet designed and developed to satisfy the requirements of BS EN 12469:2000.

It utilises a specially ventilated enclosure, developed to provide operator and environmental protection for the safe handling of chemicals and powders.

The cabinet is fitted with our Visionaire® 7" full colour touch screen control system that allows the highest level of control and monitoring. Alongside the standard Touchscreen features, the Guardian incorporates a Visual Display of Inlet velocity (m/sec or ft/min), and both Temperature & Humidity levels. The system also allows control of UV Light, Electrical Sockets, Cabinet Power and variable light intensity. Audible and Visual alarms alert the user to maintenance requirements including: Service, UV Light replacement and Cabinet Hours Run.

Options for control of popular decontamination processes (Formalin and VHP) are also provided.

Cabinet options are available for Ducted and recirculation, all units feature HEPA filtration for particulate removal and a secondary exhaust filter option is available for Activated Carbon filters (for fume containment).

Configuration

The cabinet is available with several factory configurations:

- **K-MSC1200C1** – Double HEPA filtration, internal fan recirculates airflow back into the room. Direct Duct exhaust possible (no additional fan required) for short duct run (<2m) when used with ABV (see below).
- **K-MSC1200C1(S)** – Single HEPA filtration, internal fan recirculates airflow back into the room. Direct Duct exhaust possible (no additional fan required) for short duct run (<2m) when used with ABV (see below).
- **K-MSC1200C1-NF** – Double HEPA filtration, no internal fan. MUST be ducted - Requires ABV option (see below).
- **K-MSC1200C1-(S)-NF** – Single HEPA filtration, no internal fan. MUST be ducted - Requires ABV option (see below).

Exhaust options:

- **K-MSC1200C1-ABV** – Anti-blowback device (for duct connection).

- **K-MS1200C1-CEF** – Carbon exhaust filter option (additional filter module that processes fumes/vapour)
- **K-MS1200C1-FAF** – Formalin auxiliary filter option. (Temporary filter used during the Formalin decontamination cycle to further reduce potential odours)

Technical Data

MODEL NO.	MSC1200CL1	
TOTAL AIRFLOW	380 M3/H +/- 5%	
NOMINAL AIRFLOW VELOCITY (INLET APERTURE)	0.75 m/sec	
FRONT WORKING APERTURE	200mm	
MAX APERTURE OPENING	450mm	
FRONT OPENING ACCESS (MAX)	680mm	
VOLTAGE/FREQUENCY	230V 50Hz	
POWER CONSUMPTION	2300 watts max.	
2 X AUXILLIARY POWER SOCKETS (EACH)	230V, 3 Amp	
LIGHT INTENSITY LEVEL (AT WORKSURFACE)	0->750 LUX	
SOUND LEVEL (ISO6081)	<65 dB(A)	
HEPA FILTERS	H14	
WEIGHT (NET)	180kg	
WEIGHT (SHIPPING – EXCL CRATE)	220kg	
DIMENSIONS EXTERNAL (H X W X D)	1320 X 1200 X 700mm	
MATERIALS	CABINET	POLYESTER POWDER-COATED ZINTEC STEEL
	WORKSURFACE	316 STAINLESS STEEL
	WINDOW	Laminated Glass

Normal Environmental Conditions

INDOOR OR OUTDOOR USE	INDOOR USE
TEMPERATURE	5 °C to 40°C
RELATIVE HUMIDITY	MAX HUMIDITY 80%
OVERVOLTAGE CATEGORY	OVERVOLTAGE CATEGORY II
POLLUTION DEGREE (II)	POLLUTION CATEGORY II
ALTITUDE	UP TO 2000m
MAINS SUPPLY VOLTAGE FLUCTUATION	230V -6% +10%

SECTION 2

Packaged Items

	1-OFF <i>GUARDIAN CLASS 1 BIOLOGICAL SAFETY CABINET FACTORY CONFIGURED TO YOUR SPECIFICATION</i>
	1-OFF <i>MAINS SUPPLY CABLE</i>
	1-OFF <i>GUARDIAN CLASS 1 BIOLOGICAL SAFETY CABINET USER MANUAL</i>

Installation and assembly

The cabinet will be delivered in a single piece with optional accessories such as the base stand or undercupboard accompanying as separate items.

The cabinet is provided fully configured and loaded with all filters in a ready-to-go state. As it is available with various options the installation requirements and procedures will vary according to the unit specified.

The cabinet should be sited in a suitable location, on a stable and flat surface capable of safely supporting the cabinet. It should be installed in accordance to recommendations and guidance given in BSEN12469:2000 & BS5726-2005

	WARNING
	HEAVY OBJECT. Ensure the correct lifting equipment and PPE are used during assembly. Appropriate precautions and risk assessments should be carried out prior to installation in accordance with local regulations or working practices.

Installation (general)

- Remove all packaging.
- Ensure cabinet is equally supported across the entire base and raise the cabinet to the required height by either using a lifting table or pallet lifter.
- With assistance, slide the cabinet onto the worksurface or base stand.
- When placed on a freestanding worktop/ bench, the cabinet does not need to be restrained or bolted down.
- When fitted to the optional base stand or undercupboard, the cabinet should be fixed in place using the brackets and fixings provided. (fig 2)
- Any optional items such as ABV / ducting etc. will be supplied separately and should be fitted prior to cabinet use.

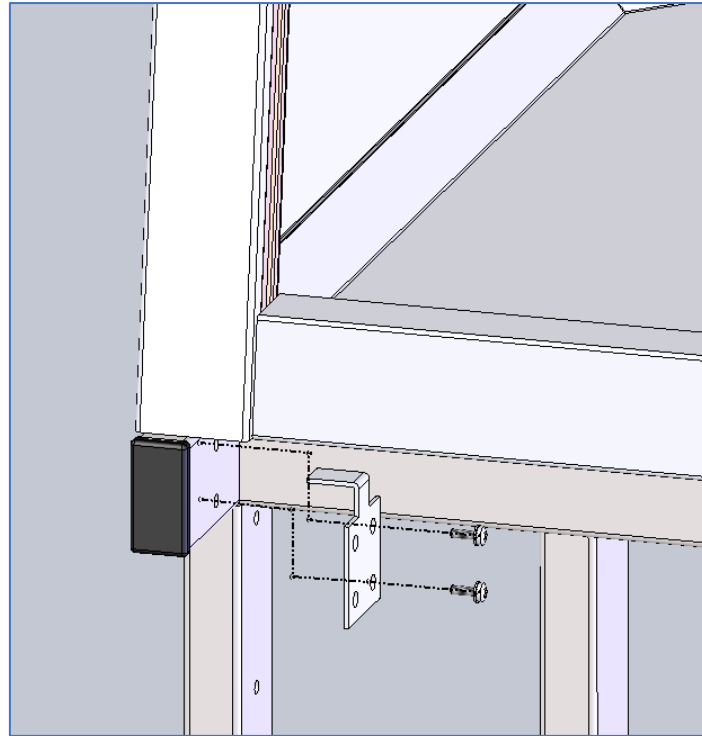



Fig 2.
Front retaining bracket (1 per side)

Installing ABV option

	ELECTRICAL HAZARD
	Ensure the mains electrical supply has been isolated before removing commencing any works on the cabinet.

To fit the anti-blowback valve you will require:

- 1 x **K-MS1200C1-ABV** Incl. fixing pack.
- 3mm Allen key
- 7mm spanner
- Decide on orientation of the ABV (options for Left/Right/Rear exit)
- Clean area around the exhaust aperture and seal area to ensure it is free of dirt and grease (we suggest the use of IPA for this purpose).
- Ensure the gasket fitted to the ABV is sound and undamaged

- Position the ABV and fix into place with the fixing kit provided – note there is a single hex-head screw provided for the hole located underneath the duct spigot. Tighten fixings to a maximum torque of 1.5Nm.

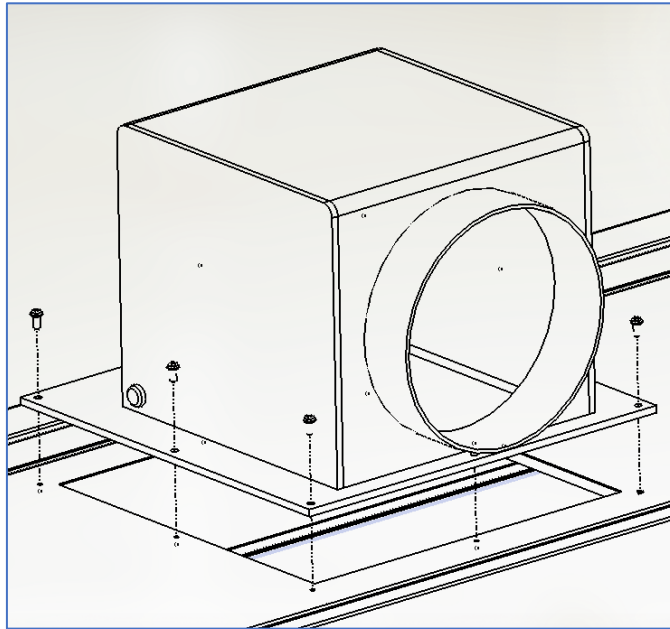



Fig 4.

Connections

The cabinet is shipped with a 2m IEC lead terminated with a standard domestic plug (type dependant on region). The lead plugs into the top, right hand side towards the rear. The IEC inlet socket is protected by a fuse. This should only be replaced with a fuse of same type and rating.

	ELECTRICAL HAZARD
	This appliance must be earthed.

	WARNING
	Before plugging the cabinet in, ensure the supply correspond to those stated in the specifications and on the serial label plate.

Auxiliary switched connection

A volt-free switching contact facility is provided for connection to external devices (eg. Duct fan). This changes state whenever the cabinet is fully operational (fan running).

The connector is located on the top of the cabinet above the electrics panel. Connection is via a supplied 3 pin plug and is wired as follows:

Terminal pin	Connection
E	N/O
N	Common
L	N/C

Testing / Commissioning

Certification is provided with each unit. Individual certificates are provided for HEPA filters.

	NOTE
	<i>The cabinet should be tested at least every 12 months.</i>

SECTION 3

General Operation

Ensure the cable is plugged in.

Operate the power switch located to right side of the cabinet.

After a short time, the control system will boot up and perform system checks, once complete, the fans will start and the lighting will be turned on at the same time, the sash will open to the normal working position. The display will show the Home page.

	NOTE
	<i>There will be a short delay of approx. 60 secs before the system and airflow reading stabilise. During this period a message of "Fan starting, please wait" is displayed. It is recommended the cabinet is NOT used until the message has cleared.</i>

Switch the cabinet on

The main switch is positioned on the upper right hand side of the front cover. Upon switching the unit on it will display the welcome screen for a few seconds:



The system will then run a system check and display the user access code screen**

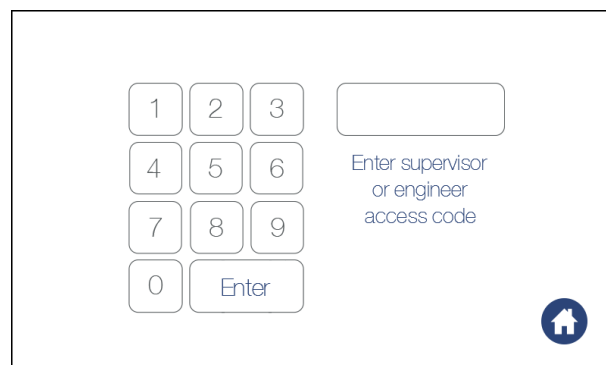

Press "0127" then "Enter" to start the cabinet. The following screen is displayed whilst the screen moves to the normal operating position.



It will then automatically open the sash to its normal working position, the fans will start and the lighting will illuminate.

During this time the following screen will be displayed:

Once the sash has reached its normal operating position and for the duration of normal day-to-day operation, the "Home" screen will be displayed and the cabinet is ready for use.

** "Keypad cabinet access" feature can be disabled in Supervisor settings detailed below.

Control Panel

The cabinet is equipped with Monmouth Scientific's Visionaire® system.

The 7" touch-screen provides complete control of the cabinet and displays all the operating parameters in an easy to understand touch screen interface.

Home Screen

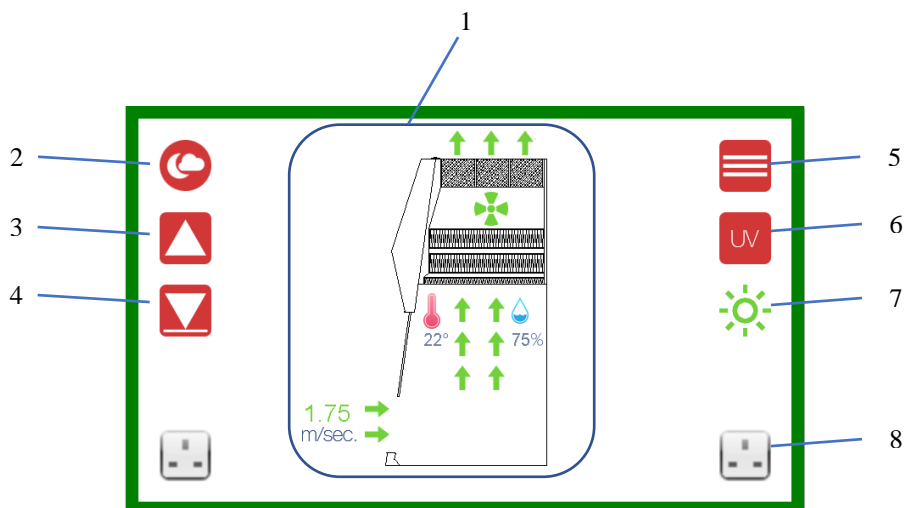

Key of features:

1. **System status display area** – Displays the aperture airflow velocity & temperature / humidity of the working space.
2. **Standby** – Closes the sash and puts the unit to into “sleep mode”.
3. **Sash up** – Press and hold to raise the sash to the desired level for access, cleaning or maintenance.
4. **Working height** – Press once and release to move the sash back to its normal working position.
5. **Menu** – Access to other features such as general cabinet info, settings & decontamination cycle.
6. **UV** – Access the setup and operation of the UV sterilisation cycle.
7. **Lighting** – Access control to set the brightness or to turn the light on/off.
8. **Socket** – Press once to turn the corresponding power socket control on/off.

Sliding sash operation

	CAUTION
	NEVER force the sash open by hand only use the controls on the touch screen.

The cabinet is equipped with an electrically actuated glass sliding sash.

It has one pre-set position this is its normal operating position.

On start-up the screen will display the following screen to warn the user it is opening.



In addition, there is an integrated safety system that automatically prevents the sash from closing should an obstruction be detected. A warning is displayed in the event of the system activating:



Remove the obstruction and press "OK". This will reset the system and the sash will close.

In addition to the normal operating position the sash can also be raised to enable access for cleaning or positioning of apparatus within the cabinet.

To raise the sash, select and hold the "*Sash up*" arrow icon (3). The sash will continue to rise until the icon is released or when it reaches the upper limit stop.

	CAUTION
	It should be noted that containment is NOT effective if the sash is raised above its normal working height.

Should the sash be moved above its normal working height position, the main display will show "**SASH HIGH**" warning the user.

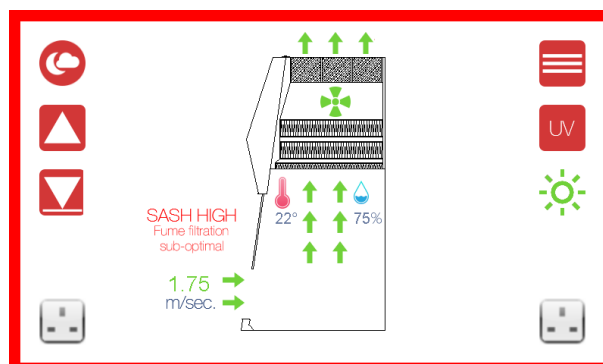

To return the sash to its normal position, press the "*Working height*" icon (4)

The sash can be also fully closed by putting the cabinet into standby – see section below for details.

System status display area

The current status of the main cabinet parameters is displayed within this area.

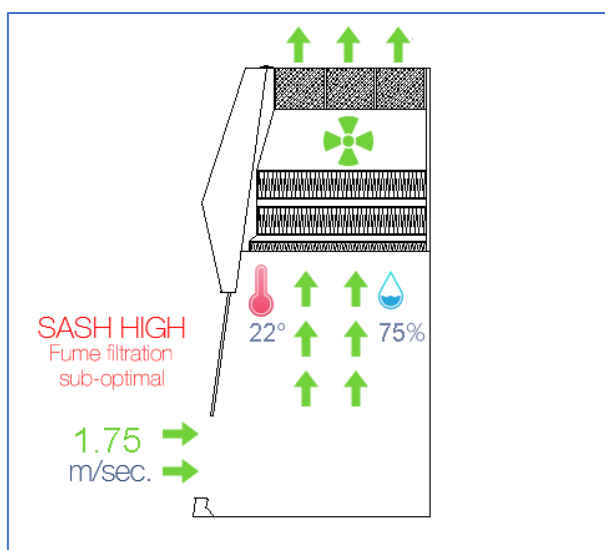

Parameters shown include:

- Working aperture airflow velocity (m/sec)
- Working space temperature (°C)
- Working space relative humidity (%)

In addition, the status of the filters is monitored and warnings displayed in the event of blockage (HEPA) and breakthrough (Carbon).

In the event of any filter or airflow warnings being displayed, the border of the display also turns red and an alarm beep will sound.

Standby

Standby is a status where the cabinet is closed, the lighting is turned off and the fans are stopped. The control system is still operational.

To put the cabinet into standby, first ensure any items or obstructions are removed from the front edge of the worksurface then press the "Standby" icon (2).

If the "Keypad cabinet access" option is active, the user will be prompted to enter the access code (0127).

A warning screen is displayed with a 5 second countdown advising that the screen will shortly close (Pressing "Abort shut down" will stop the countdown and the cabinet will resume normal operation).

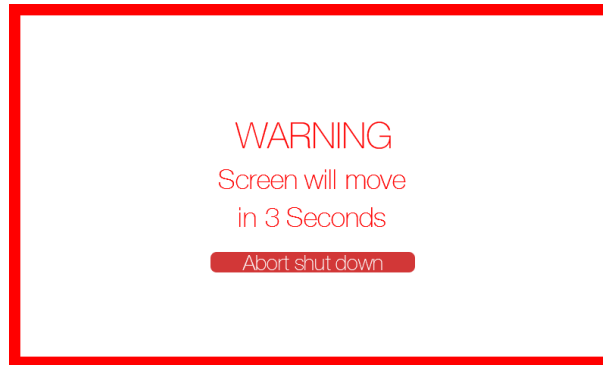

Once the sash has closed, the fans and lights will switch off and the standby screen is displayed.

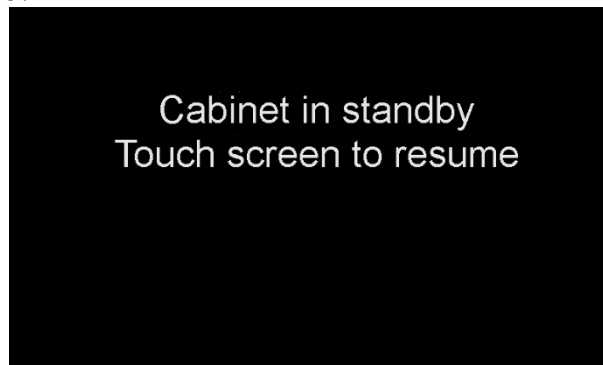

Touching the screen will wake the cabinet , open the sash, start the fans and resume operation.



Switch off

Once the cabinet is in standby mode it can be safely turned off at the power switch.

	CAUTION
	The cabinet should not be turned off if the sash is open as containment will be affected.

Lighting

The cabinet is equipped with low energy LED lighting. The lighting levels can be adjusted or turned by pressing the "Lighting" icon on the home screen (7). This expands to reveal the following options:

-  — Increase brightness
-  — On/Off
-  — Decrease brightness

By pressing the “Up” or “Down” arrows you can adjust the brightness. Pressing the “Lighting” icon will turn the light off. Pressing the icon again will turn the light on.

The screen will return to the home page after 3 seconds if no icon is pressed.

Auxiliary power sockets

As standard, the cabinet is equipped with 2 auxiliary power outlet sockets for connection of ancillary equipment/apparatus.

The sockets are fuse protected and rated at 3A (700w) each.

	ELECTRICAL HAZARD
	Do not exceed the stated load.

The socket outlets are switched by pressing the corresponding icon on the home screen (8).

Once activated, the relevant icon is illuminated with a red border to indicate it is switched on.

By default, the sockets are left powered on whilst the cabinet is in standby mode. They can be set so they automatically turn off when the cabinet goes into standby mode – this option is set in the “Supervisor settings” page.

The sockets are always turned off when the cabinet is switched off.

SECTION 4

Cleaning and decontamination

General Cleaning

Surface cleaning and decontamination

The powder coated surfaces should be kept clean to preserve the finish by preventing stains. Only soapy water or mild detergents should be used on painted surfaces, abrasive products and harsh chemical cleaners should be avoided.

The upper cabinet (unpainted areas), sink and inlet grilles are all made from 316 stainless steel. The work surface will be either glass, plastic or 316 stainless steel depending on the configuration option. These surfaces are resilient against many chemicals however it is the user responsibility to determine the compatibility of the chemicals used within the cabinet and their effect on the materials they may come into contact with.

Glass front cleaning and decontamination

	WARNING
	Do not attempt to open the front cover without either fully raising or closing the sliding sash – potential glass breakage may occur if this instruction is not followed.

With the sash fully raised (see sash operation section) open the front panel, the entire internal surface of the sash may be cleaned.

With the sash fully closed (see sash operation section), the front panel can be raised to allow for full cleaning of the front surface of the sash.

UV Disinfection

	NOTE
	For the UV lamp to be effective, the target MUST be in direct line of sight with the light source. It is the user's responsibility to satisfy themselves whether it is suitable for the intended process.

The cabinet is equipped with a ultraviolet germicidal lamp for additional disinfection purposes. The lamp is UV-C (254nm) 30w.

The feature is accessed by pressing the corresponding icon on the home screen (6).

The sash will fully close and the "UV Disinfection" screen will be displayed.

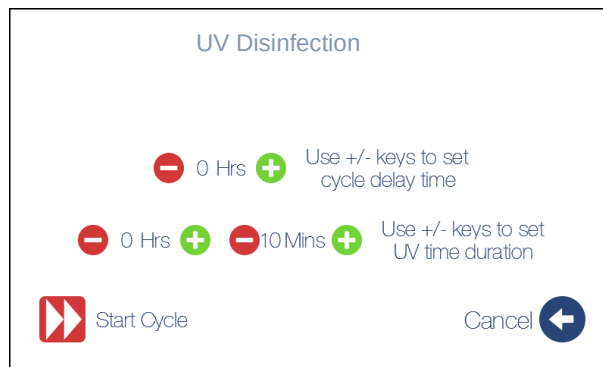

Follow the on-screen prompts to set cycle duration and delayed start time. You can press the **"Cancel"** icon at any time to abort the setup screen and return to the Home screen.

Pressing **"Start cycle"** will close the sash, turn the fans off and start the UV cycle or put the cabinet into standby if a delay time has been set. Information of the current UV status is displayed throughout the cycle.

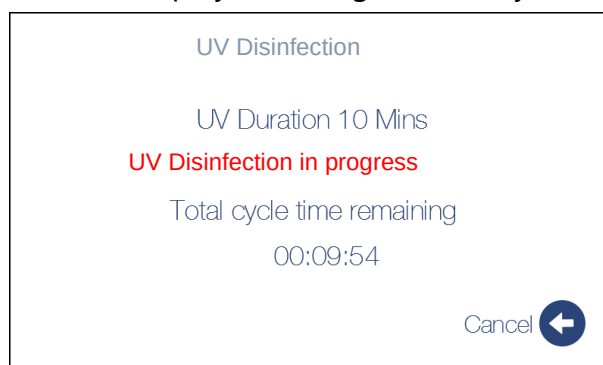

Once complete, the following screen is displayed, press the home button return to the home page.

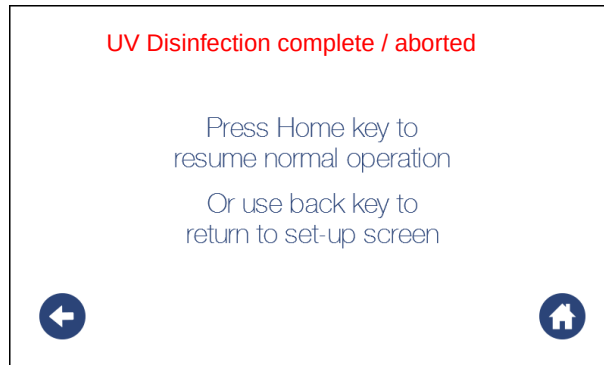

Decontamination with Formaldehyde – introduction

This section should be read in conjunction with annex J of BS12469:2000 to gain full understanding of recommendations for decontamination, cleaning and fumigation of Microbiological Safety Cabinets and filters.

Monmouth Scientific can supply a suitable Formalin vaporiser and neutraliser for use with the cabinet. The vaporiser simply plugs into the electric socket inside the cabinet and the entire decontamination process runs under the control of the cabinet.

	NOTE
	Please thoroughly read the vaporiser manual provided before running a decontamination cycle.

Decontamination with Formaldehyde – for all cabinets EXCEPT those supplied with the Optional temporary removable carbon exhaust filter kit (K-MSCC1-FAF)

Preparation prior to decontamination

- Place the vaporiser inside the cabinet and prepare it in accordance with the user manual.
- Plug the unit into the lower electric socket outlet of the cabinet.
Ensure socket is turned off before plugging the unit in.
- From the Home screen, press “Menu” icon and select “Form”
- Follow the on-screen instructions:

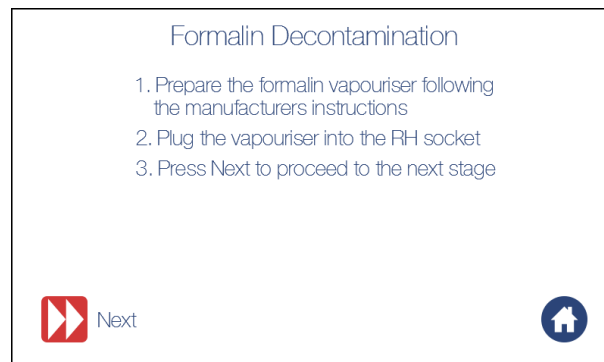



- Seal glazing and front cover surrounds with suitable self-adhesive tape.
- Fit the supplied outlet cover plate to seal the cabinet outlet. It is also recommended that this cover is sealed with suitable self-adhesive tape to provide a secondary seal.
- Press **"Next"** to proceed to the next page to setup cycle time parameters.

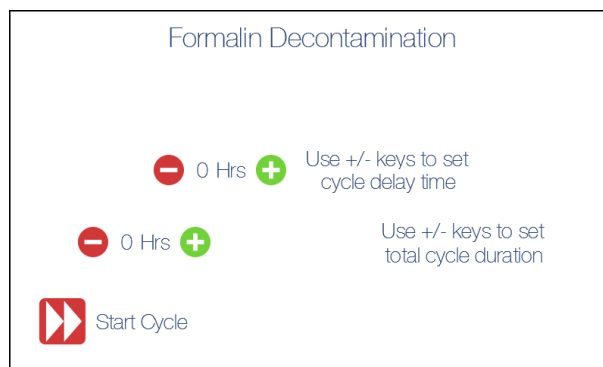

- Select cycle time/duration accordance with vaporiser manufacturer's instructions.
- During the course of the cycle, the fans will occasionally run to aid circulation of the vapour.

At the end of the cycle, follow the instructions displayed on screen:

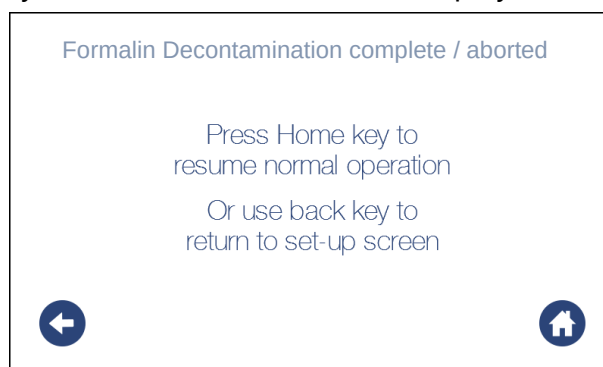

Decontamination with Formaldehyde – Only for cabinets fitted with the optional carbon exhaust filter kit (K-MSCC1-FAF)

This is a factory order option that consists of an adapted outlet hood, carbon filter and quick-release mounting kit that fits to the top of the cabinet when full carbon exhaust filters are not fitted. This can be used whenever the decontamination cycle is run and allows for the safe and effective removal of residual formaldehyde fumes following the cycle.

	WARNING
	Due to the specific grade of activated Carbon this option is only suitable for use with Formaldehyde.



The setup sequence is similar to a cabinet fitted with either full carbon or no carbon exhaust filters but with additional instructions displayed at the appropriate time.

Preparation prior to decontamination

- Place the vaporiser inside the cabinet and prepare it in accordance with the user manual.
- Plug the unit into the lower electric socket outlet of the cabinet.
Ensure socket is turned off via the screen before plugging the unit in.
- From the Home screen, press **"Menu"** icon and select **"Form"**
- Follow the on-screen instructions:

Formalin Decontamination

1. Prepare the formalin vapouriser following the manufacturers instructions
2. Plug the vapouriser into the RH socket
3. Press Next to proceed to the next stage

 Next

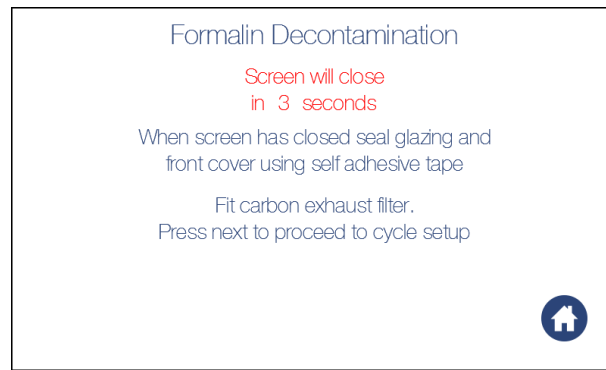

- Seal glazing and front cover surrounds with suitable self-adhesive tape.
- Fit the Carbon filter and retaining frame to the top of the cabinet outlet. Lock into place with the spring catches.
- Press "Next" to proceed to the next page to setup cycle time parameters.

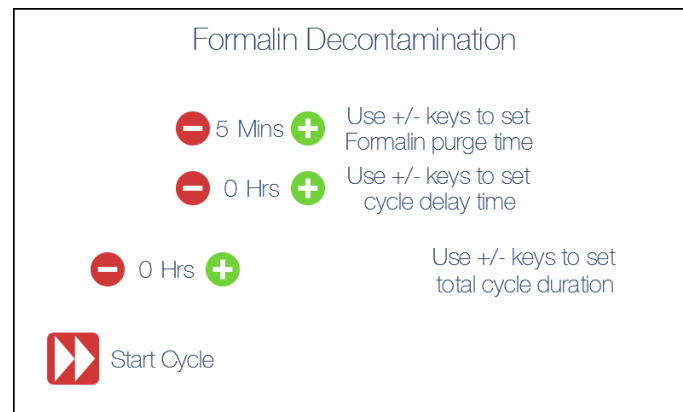

- Select duration for post cycle purge.
- Select cycle delay time /cycle duration accordance with vaporiser manufacturer's instructions.
- During the course of the cycle, the fans will occasionally run to aid circulation of the vapour.
- Towards the end of the cycle, follow instructions to remove the seal tape and press continue, the cycle will continue for the preset time to purge the working space, during this time the Carbon filter will absorb the residual fumes. Please note the removable carbon filter option is NOT monitored for breakthrough. The user should use alternative methods (e.g Air sample tubes) to test and monitor the filter condition.

At the end of the cycle, follow the instructions displayed on screen:

Formalin extraction cycle running

When cycle is complete remove carbon
filter from top of cabinet.
Press home key to return to normal operation

SECTION 5

Supervisor settings

This passcode protected menu page allows supervisors to set cabinet and cycle specific preferences and parameters that regular users cannot access or change.

It is accessed from the home screen by selecting *"Menu"* then the *"Settings"*  icon.

This opens the password protected access screen

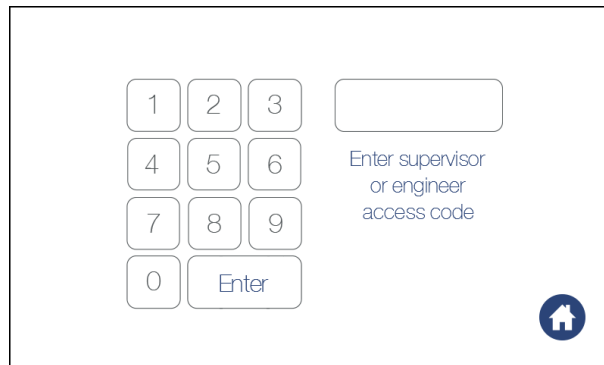

Enter the passcode to access the supervisor settings screen.

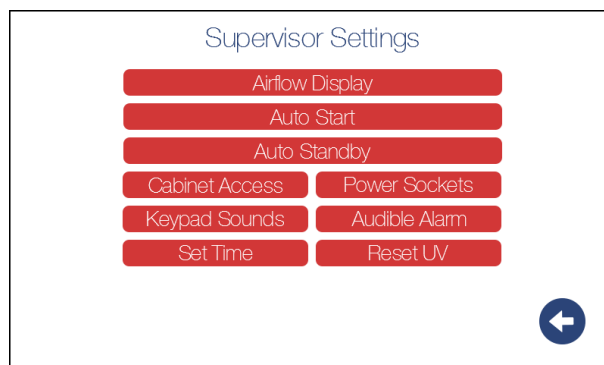

Select the options as required and select the *"Return"* icon to save and return to the password screen.

Settings that offer supervisor access to options and parameter settings:

- Airflow display – Selects the units displayed on the home page

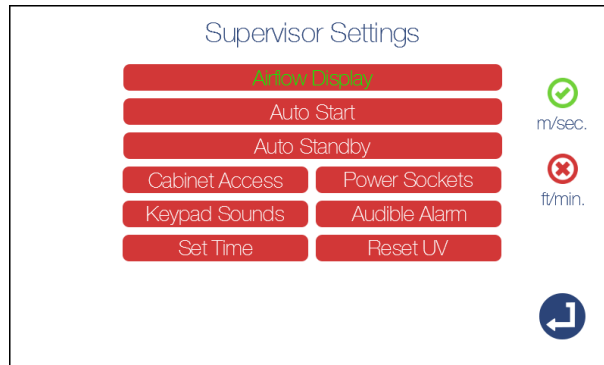

- Auto Start – This feature allows the user to set the cabinet to allow automatic startup at a preset time/day.
A practical example of this feature would be if a user would like the cabinet to start prior to arrival and purge for 30mins before the start of the working day.

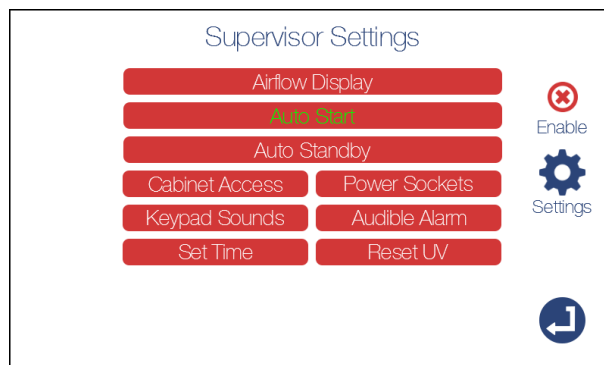

Press enable to activate or deactivate.

Press the "settings" icon to adjust time and day preferences.

Press back to return to the supervisor settings menu.

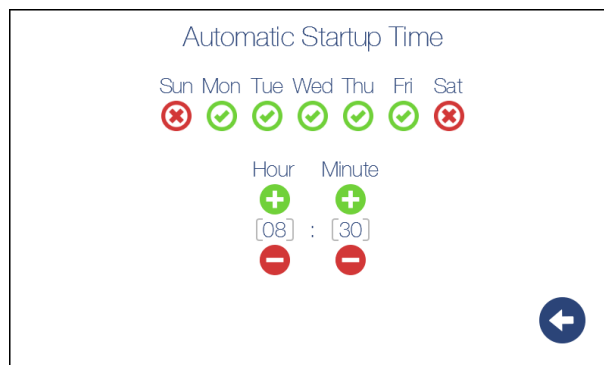

- Auto Standby – This feature allows the user to set the cabinet to allow automatic standby at a preset time/day.

A practical example of this feature would be if a user would like the cabinet to automatically shut down and enter standby at the end of the working day. This is particularly useful if users are prone to leaving cabinets running unnecessarily.

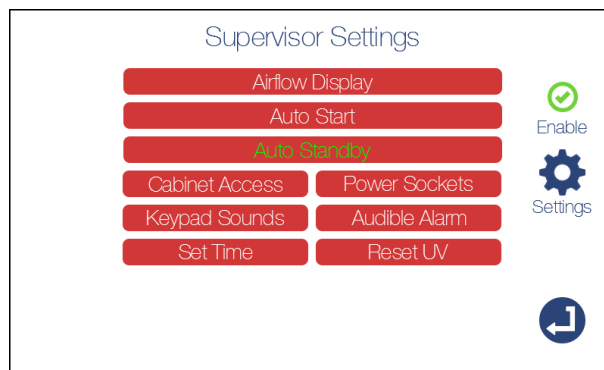

Press enable to activate or deactivate.

Press the *"settings"* icon to adjust time and day preferences.

Press back to return to the supervisor settings menu.

- Cabinet access – Enabling this feature will mean users will be prompted for the user passcode prior to startup. This prevents unauthorised use.

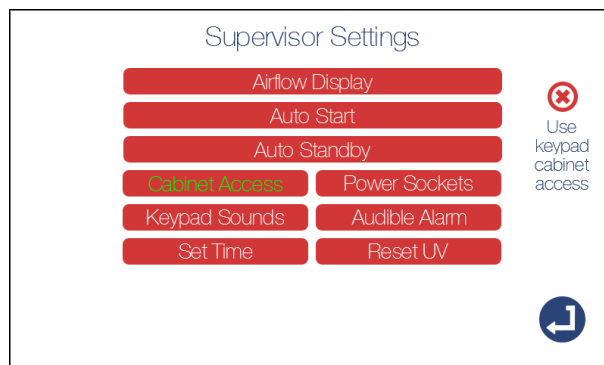

- Power sockets – Enable or disable to automatically turn off Auxiliary power sockets when the cabinet goes into standby mode.

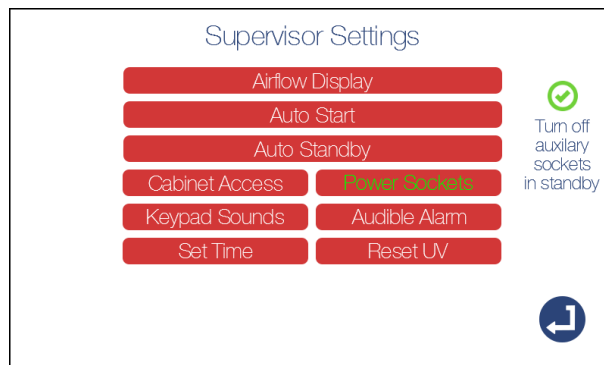

- Keypad sounds – Enable or disable to allow beeps when keypad is pressed.

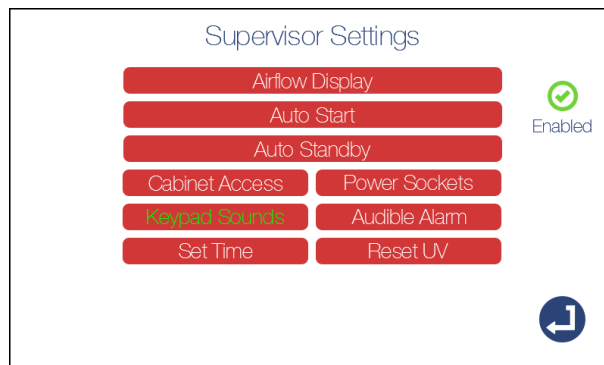

- Audible alarm – Enable or disable to allow warning sounds whenever an alarm state is displayed.

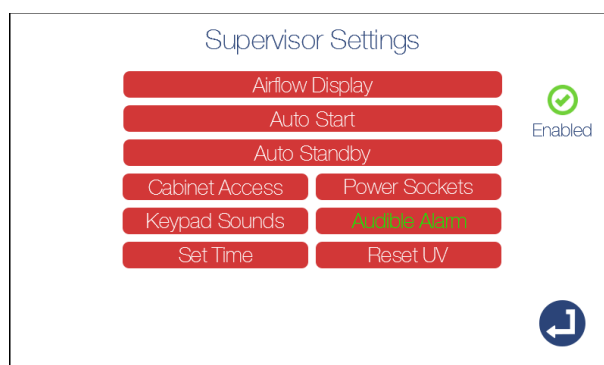

- Set time – Adjust the time as required and press “Enter” to set. Press “Back” to return to the menu.

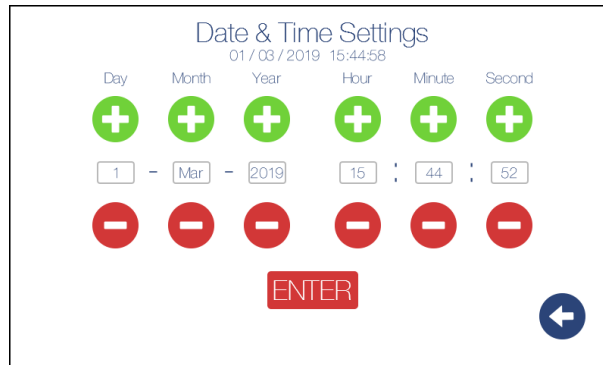

- Reset UV - Resets the UV tube hours (when tube is replaced – see section 5 – “Calibration and maintenance” for details).

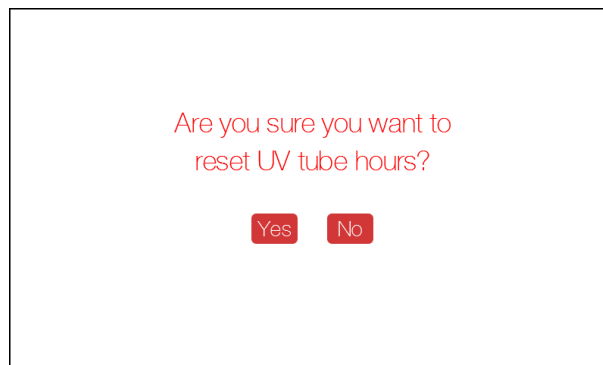



SECTION 6

Maintenance

To ensure reliable containment and optimum performance the cabinet must be maintained in accordance with the service intervals detailed. Filters must be changed promptly when indicated on the display panel.

Fuses

	ELECTRICAL HAZARD
	If a fuse blows, ensure the unit is checked thoroughly to identify any faults with the electrical components or connected circuitry.

	ELECTRICAL HAZARD
	Isolate cabinet before changing fuses

Replacing Main Fuse

The mains fuse is located on the rear of the cabinet on the power inlet socket. Use a suitable flat head screw driver to open the fuse holder. Replace with type T, 5 x 20mm, 10A fuse.

Replacing Auxiliary Fuses

Various fuses are used for circuit protection of individual system components.

To change

- Put unit into standby mode and turn off. Unplug and isolate the cabinet.
- Lift up the front cover. Fuses are located inside the head on the right-hand side.

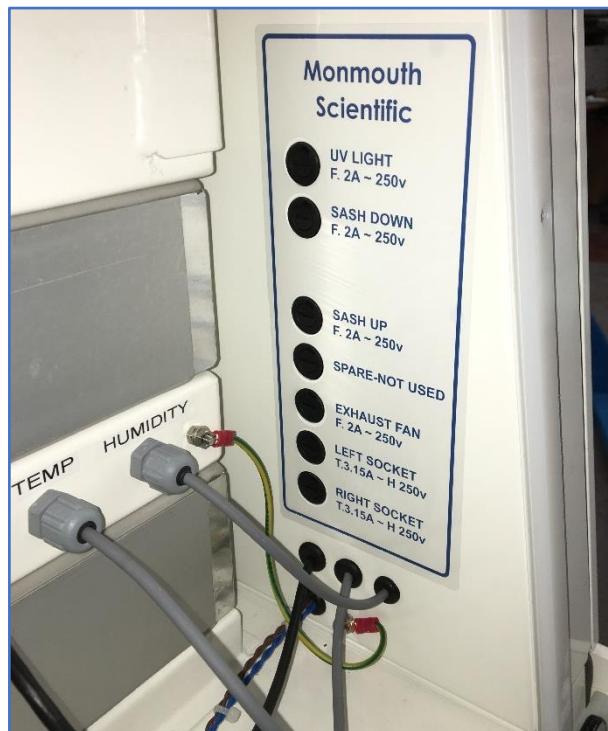

- Use a suitable flat head screw driver to open the fuse holder. Replace fuses with type T, 5 x 20mm. Use Amp rating shown on label to select correct fuse.

UV lamp – changing

	ELECTRICAL HAZARD
	Isolate cabinet before changing UV lamp

• Monmouth replacement part No

GS-00432

- The lamp is located inside the working space/chamber, to access: From the home screen, press and hold the “up” arrow to fully open the sash.
- Turn the cabinet off at the main switch – Do NOT put cabinet into standby.

With the sash still fully up, open the front panel.



- Reach inside and locate the lamp (tube).
- Rotate 90° and remove from cabinet.
- Refitting is the reverse process of removal.
- Once replaced, reset the UV hours counter (see Supervisor settings for details)

Filter Changing

	BIOHAZARD
	This cabinet could be used for manipulations of bio hazardous and toxic materials therefore internal components and filters could be contaminated. Service personnel must therefore observe strict safety precautions when handling potentially contaminated material.

All cabinets:

- From the home screen, press and hold the “up” arrow to fully open the sash.
- Turn the cabinet off at the main switch – Do NOT put cabinet into standby.
- With the sash still fully up, open the front panel.



Replace prefilters

- Monmouth replacement Pre-Filter part No

PF-0161



Thumbscrews

- Unscrew the retainer thumbscrews
- Slide the prefilter towards the front then lower down from the rear to release.

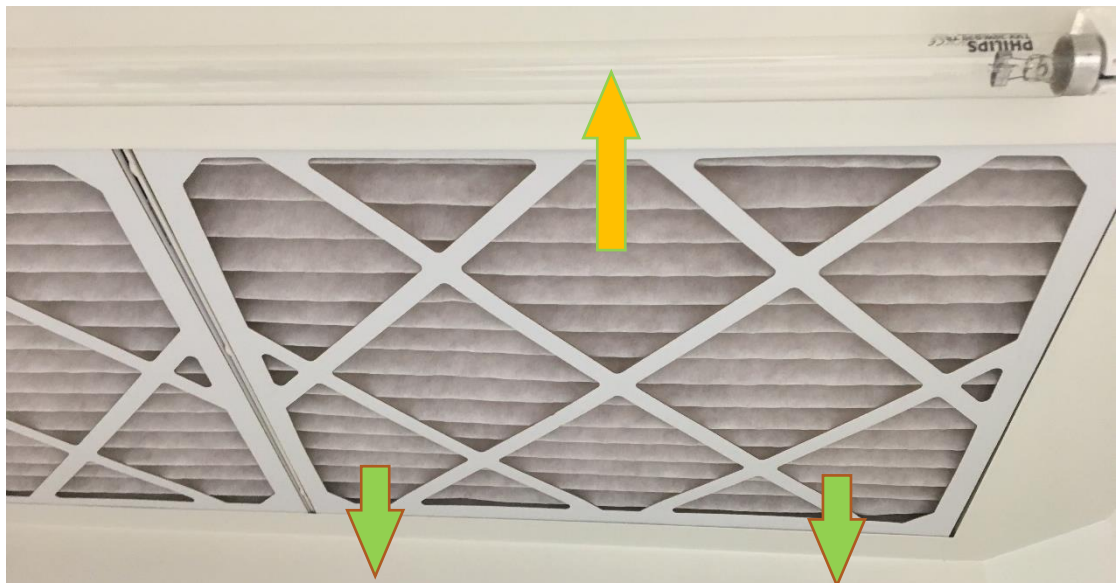

- Refitting is the reverse process of removal.

Replace main HEPA filters

- **Monmouth replacement HEPA part No**

k-HF0227

- With the front cover raised as described above, locate the 4 off filter clamping screws (13mm socket and extension bar required).

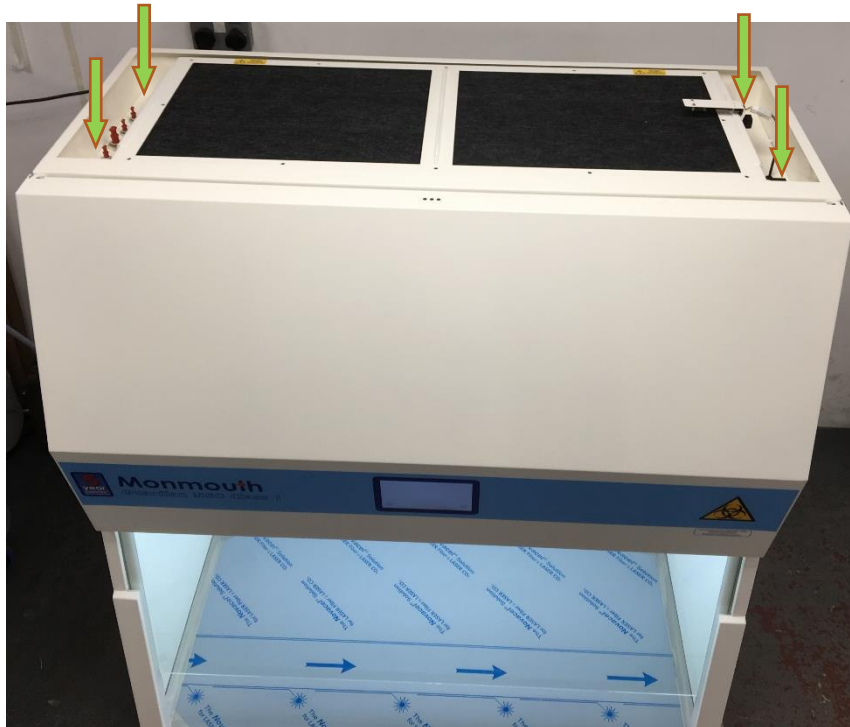

- Undo the screws to raise the filter clamping mechanism.

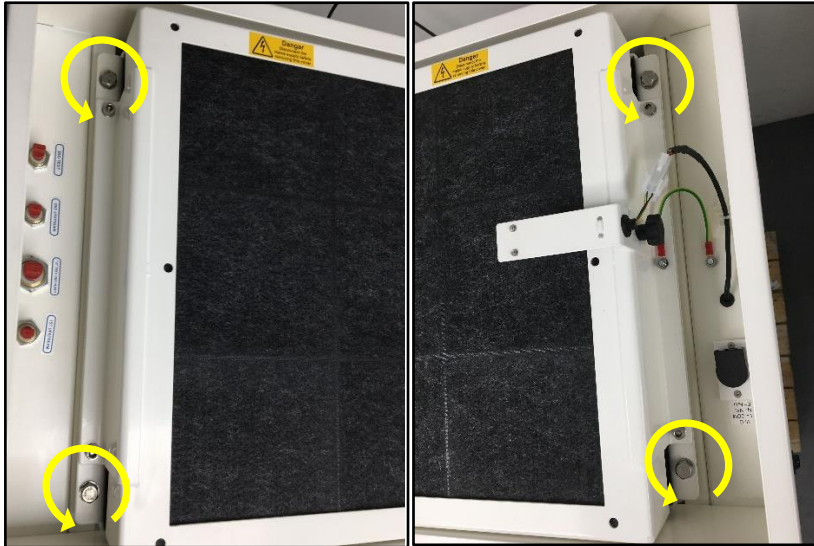

- Continue to raise until a sufficient gap (10-15mm) is made to allow each filter to be removed.

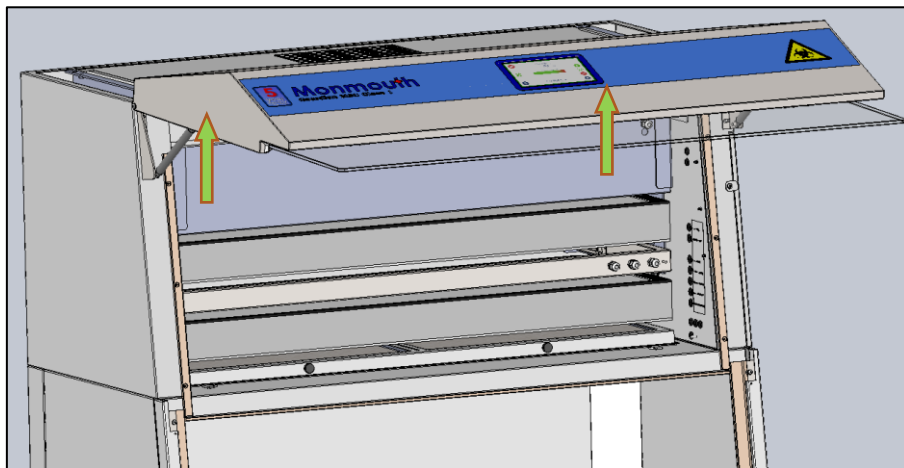

- Slide each filter out and bag for disposal.

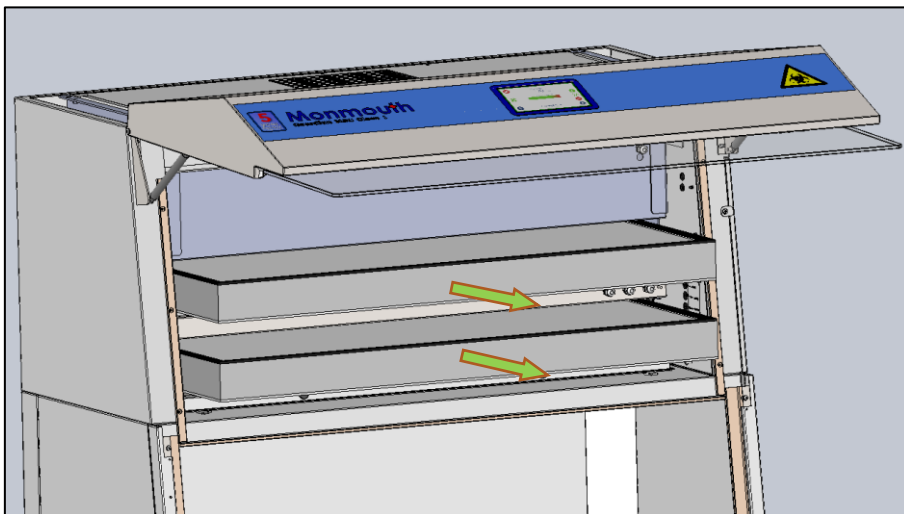

- Refitting is the reverse process of removal.

i	NOTE
	It is recommended to always change the pre-filters when installing new HEPA filters.

i	NOTE
	Filter should be fully tested (DOP) before cabinet is used.

DOP test facilities

Test ports are provided for upstream and after filter DOP testing. These are located on top left hand side of the cabinet.

Where only 1 HEPA is fitted, connect the upstream sample into "1st Upstream" port & after-filter downstream sample into "1st Test/2nd inject" port.

Where 2 HEPA filters are fitted the 2nd filter should be tested by injecting DOP smoke into the "1st Test/2nd Inject" port, connect upstream sample into "2nd Upstream" port and after-filter downstream sample into "2nd Test" port.



Replace Carbon exhaust filters

	NOTE
	Many options are available for carbon filters and their use is specific to application – please check with Monmouth Scientific for correct carbon filter code prior to ordering

- Where fitted, Locate the filter sensor assembly (top of cabinet), unplug and loosen thumbscrew. Slide upwards to remove the bracket/sensor assembly from cabinet and store in a safe location.

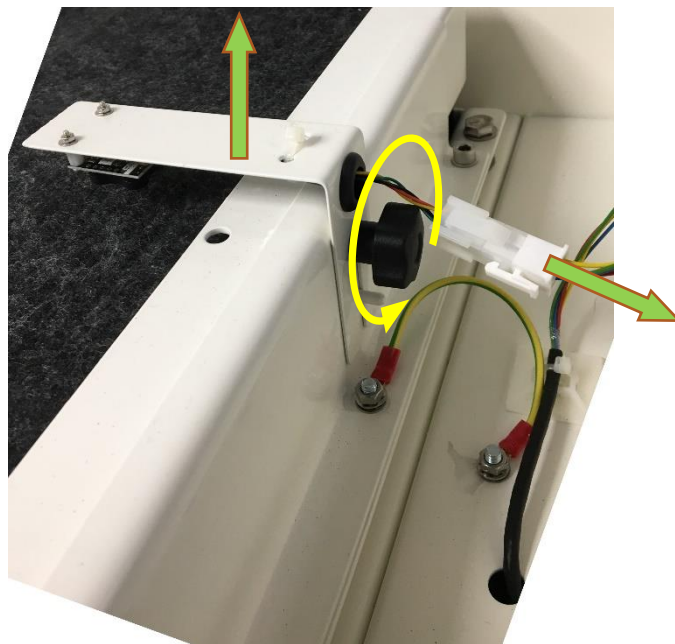

- With the front cover raised as described above, locate the 4 off filter clamping screws (Allen key required).

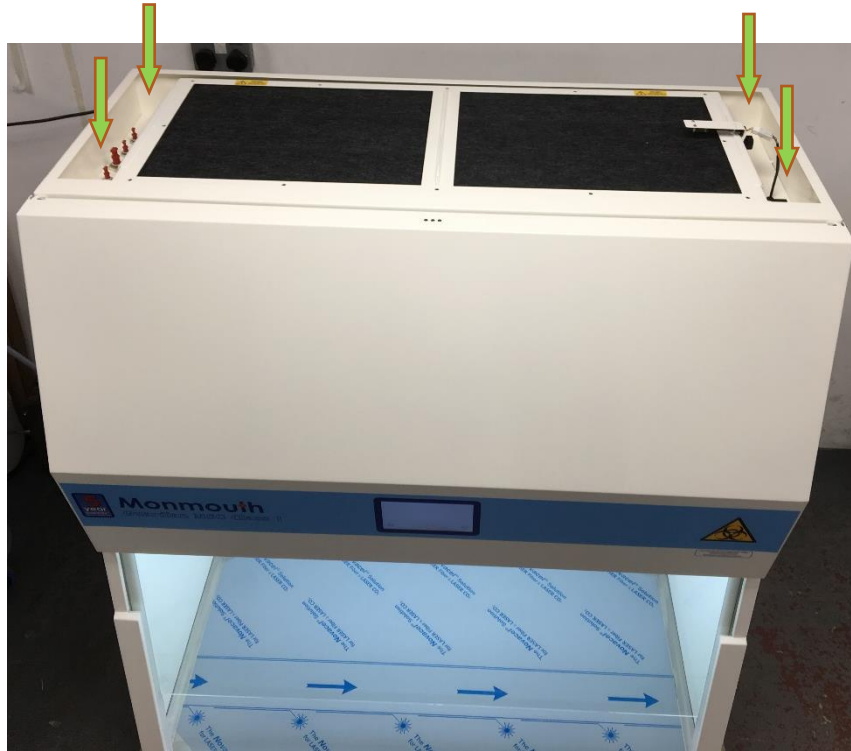

- Fully slacken and remove.

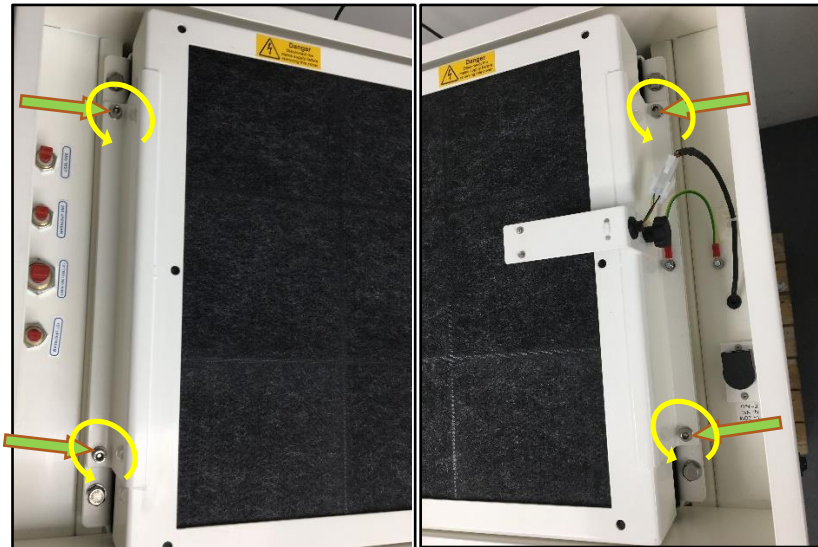

- Remove the frame.

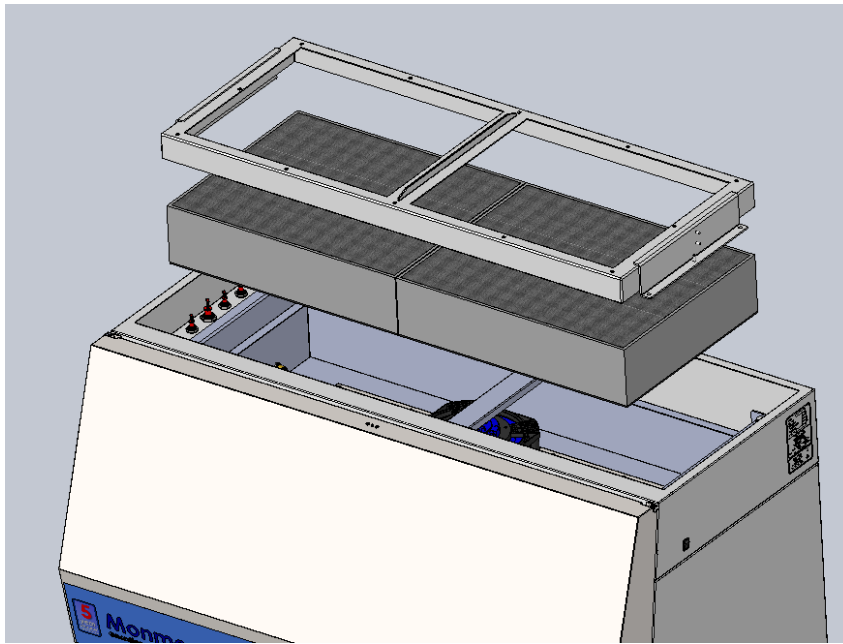

- Remove the filter(s) and bag for disposal.
- When refitting the filter, ensure the seal face of the cabinet is clean and free from obstructions. Fit filter with foam face down.
- Refit frame and screws - tighten to min 1.5 N-m torque.
- Refit the sensor and reconnect the cable.

SECTION 7

Servicing

An annual service is recommended to maintain optimum operating conditions and will include the following points:-

- Test unit for full functionality
- Replace pre-filter elements.
- DOP test HEPA filter/s.
- Check filter inlet and exhaust outlet air flows.
- Check general condition of cabinet - fasteners, seals, corrosion etc.
- Inspect electrical components.
- Issue test report and airflow certificate.
- **Install software updates if available.**
- **Note any feedback from customer.**

Monmouth Scientific



Units 5 & 6 Kilnside
East Quay
Bridgwater
Somerset TA6 4DB

<https://monmouthscientific.co.uk>



info@monmouthscientific.co.uk

+44 (0) 1278 458090

